

# DURALAST DWS 24X24

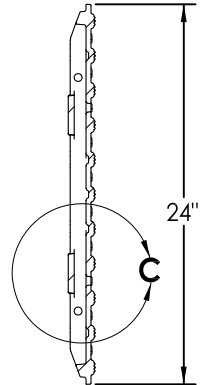

SECTION B-B

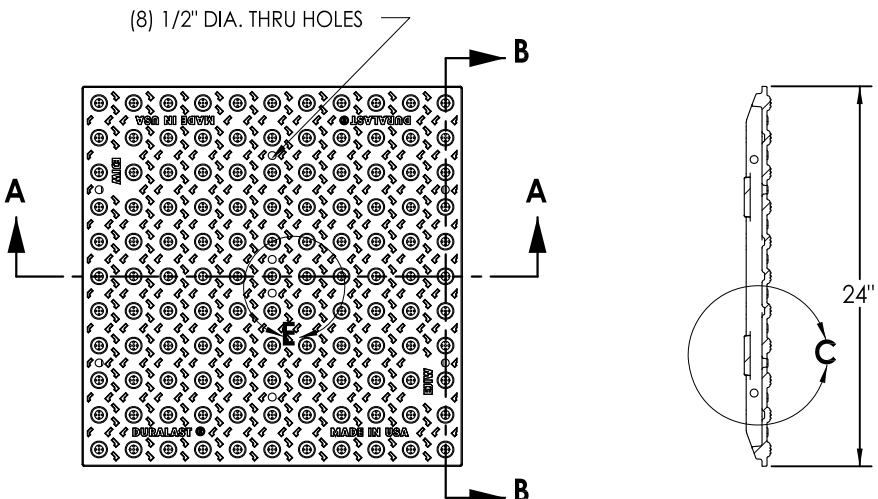
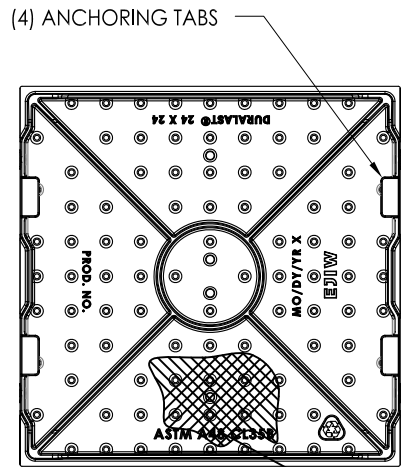

BOTTOM VIEW

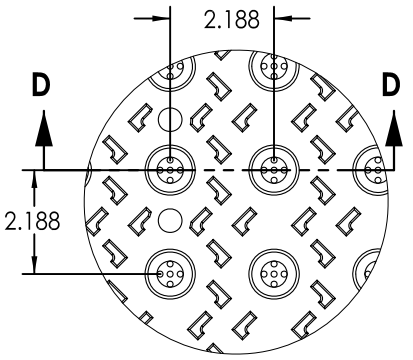

DETAIL E

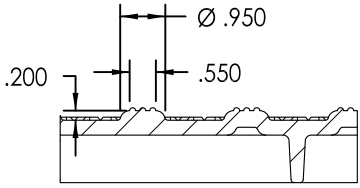

SECTION D-D  
SCALE 1:4

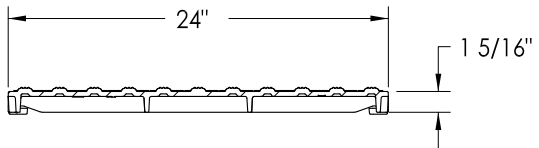

SECTION A-A

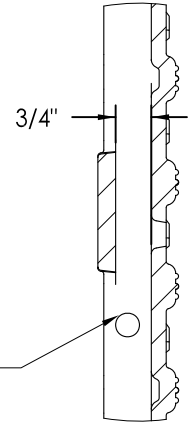

DETAIL C

1/2" DIA. HOLES (4)  
PLACES (FOR BOLTING)  
HAND TIGHTEN ONLY

## PRODUCT NUMBER

00700571

## DESIGN FEATURES

- MATERIALS:  
COVER - GRAY IRON  
ASTM A48 CL35B
- DESIGN LOAD:  
N/A
- COATING:  
UNDIPPED
- OPEN AREA  
N/A

## DESIGN INTENT

- DETECTABLE WARNING SURFACE
- COMPLIANT WITH ADA ACCESSIBILITY GUIDELINES (ADAAG SECTION R304)
- MAINTENANCE FREE
- SIMPLIFIED INSTALLATION

## INCLUDED FEATURES

- SLIP RESISTANT SURFACE  
with the ALL? registered trademark
- ANCHORING TABS:  
HOLDS DWS IN CONCRETE
- BOLTING:  
CONNECTS MULTIPLE PLATES

## ALTERNATE OPTIONS

- COATINGS:  
MULTIPLE COLORS

## DRAWING DETAILS

ORIGINAL DRAWING: 11/23/2009  
REVISED BY: DEF 2/19/2010

Corporate Headquarters  
301 Spring Street  
PO Box 439  
East Jordan, MI  
49727-0439  
800.874.4100



Call Today for More Information

800.626.4653 **EJIW EAST JORDAN** IRON WORKS EST. 1883 www.ejiw.com  
WE COVER YOUR INFRASTRUCTURE® MADE IN THE USA

Weights (lbs./kg.), dimensions (inches/mm.), and drawings provided for your guidance. We reserve the right to modify specifications without prior notice. Uncontrolled distribution.

CONFIDENTIAL: This drawing is the property of East Jordan Iron works, Inc., and embodies confidential information, registered marks, trade secret information, and/or know how that is the property of East Jordan Iron Works, Inc. Copyright 2009 East Jordan Iron Works, Inc.